

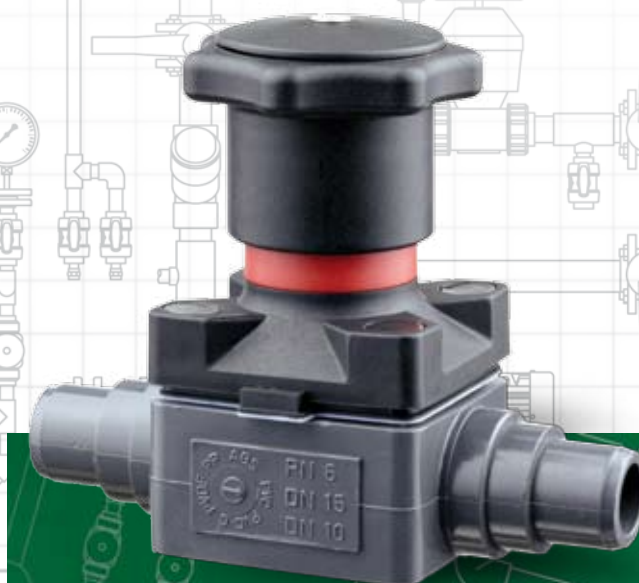

Valvola a membrana compatta
Compact diaphragm valve
Vanne à membrane compacte
Kompaktes Membranventil

CM PVC-U



I dati del presente prospetto sono forniti in buona fede. La FIP non si assume alcuna responsabilità su quei dati non direttamente derivati da norme internazionali.
La FIP si riserva di apportarvi qualsiasi modifica.

The data given in this leaflet are offered in good faith. No liability can be accepted concerning technical data that are not directly covered by recognized international Standards.
FIP reserves the right to carry out any modification to the products shown in this leaflet.

Les données contenues dans cette brochure sont fournies en bonne foi. FIP n'assume aucune responsabilité pour les données qui ne dérivent pas directement des normes internationales.
FIP garde le droit d'apporter toute modification aux produits présentés dans cette brochure.

Alle Daten dieser Druckschrift werden nach bestem Wissen angegeben, jedoch besteht keine Verbindlichkeit, sofern sie nicht direkt internationalen Normen entnommen wurden. Die Änderung von Maßen oder Ausführungen bleibt FIP vorbehalten.

Valvola a membrana compatta

La CM è una valvola a membrana a comando manuale, di dimensioni ridotte e struttura particolarmente compatta, ideale quindi per impiego in spazi ristretti.

Gli organi di manovra interni, isolati dal fluido, sono in metallo.

L'innovativo sistema di tenuta CDSA

- Circular Diaphragm Sealing Area -

offre i seguenti vantaggi:

- distribuzione uniforme della pressione dell'otturatore sulla membrana di tenuta

- facilità di pulizia delle zone interne della valvola

- minimizzazione del rischio di accumulo di depositi, contaminazione o danneggiamento della membrana a causa di fenomeni di cristallizzazione

- riduzione della coppia di manovra

PECULIARITÀ:

-
-
-
-
-
-
-
-
-
-
-
-
-
-
-
-
-

Compact diaphragm valve

-
-
-
-
-
-
-
-
-
-
-
-
-

Vanne à membrane compacte

-
-
-
-
-
-
-
-
-
-
-
-
-
-
-
-
-

Kompaktes Membranventil

-
-
-
-
-
-
-
-
-
-
-
-
-
-
-
-
-

CM PVC-U

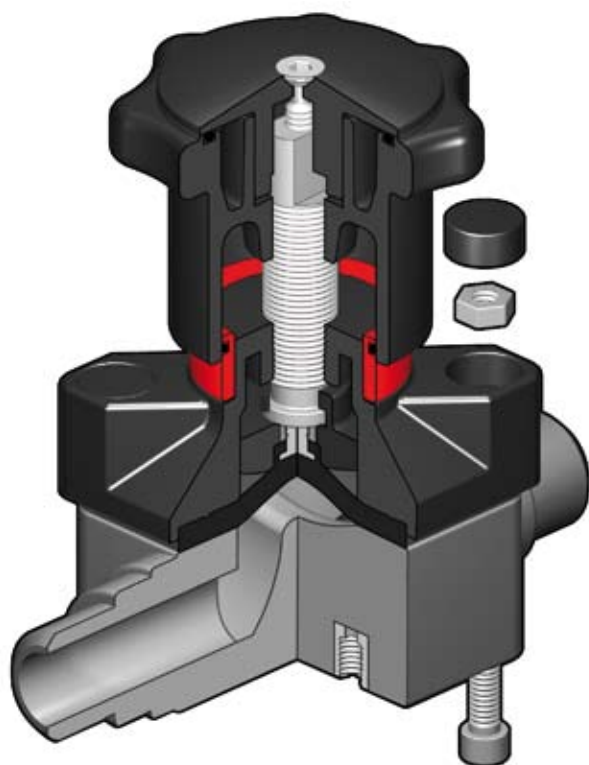

Legenda

**Dati
Tecnici**

**Technical
Data**

**Données
Techniques**

**Technische
Daten**

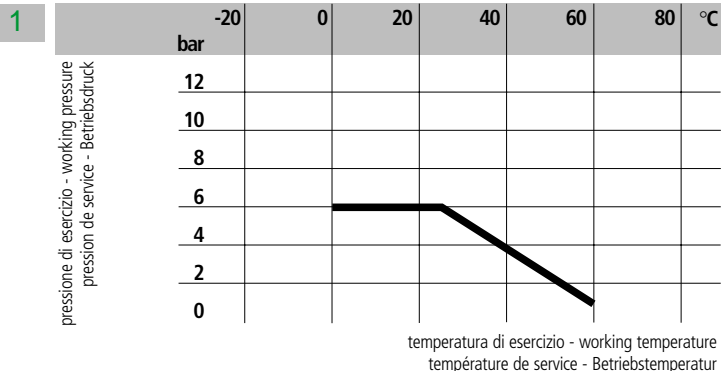

2

DN	12	15
k_{v100}	47	60

Pressione di esercizio - Working pressure Pression de service - Betriebsdruck	max. 6 bar
Materiale della membrana di tenuta - Diaphragm material Matériaux de la membrane - Membranwerkstoff	EPDM - FPM PTFE**
Materiale del corpo valvola - Valve body material Matériaux de la vanne - Gehäusewerkstoff	PVC-U

** Per i fluidi con elevate proprietà permeanti sono disponibili membrane speciali
 ** Special diaphragms are available for permeation-diffusion
 ** Des membranes particulières sont disponibles pour fluides permeant
 ** Für Permeation/Diffusion sind Sondermembranen lieferbar

1 Variazione della pressione in funzione della temperatura per acqua o fluidi non pericolosi nei confronti dei quali il materiale è classificato CHIMICAMENTE RESISTENTE. In altri casi è richiesta un'adeguata diminuzione della pressione nominale PN. (25 anni con fattore di sicurezza).

Pressure/temperature rating for water and harmless fluids to which the material is RESISTANT. In other cases a reduction of the rated PN is required. (25 years with safety factor).

Variation de la pression en fonction de la température pour l'eau et les fluides non agressifs pour lequel le matériau est considéré CHIMIQUEMENT RESISTANT. Pour les autres cas une diminution du PN est nécessaire. (25 années avec facteur de sécurité inclus).

Druck/Temperatur-Diagramm für Wasser und ungefährliche Medien gegen die das Material BESTÄNDIG ist. In allen anderen Fällen ist eine entsprechende Reduzierung der Druckstufe erforderlich. (Unter Berücksichtigung des Sicherheitsfaktors für 25 Jahre).

2 Coefficiente di flusso k_{v100}
Per coefficiente di flusso k_{v100} si intende la portata Q in litri al minuto di acqua a 20° C che genera una perdita di carico $\Delta p = 1$ bar per una determinata apertura della valvola.
I valori k_{v100} indicati in tabella si intendono per valvola completamente aperta

Flow coefficient k_{v100}
 k_{v100} is the number of litres per minute of water at a temperature of 20° C that will flow through a valve with a one-bar pressure differential at a specified rate. The k_{v100} values shown in the table are calculated with the valve completely open

Coefficient de débit k_{v100}
 k_{v100} est le nombre de litres par minute d'eau, à une température de 20° C, qui s'écoule dans une vanne de régulation avec une pression différentielle de 1 bar à une vitesse donnée. Les valeurs k_{v100} indiquées sur la table sont évaluées lorsque le robinet est entièrement ouvert

k_{v100} -Werte
Der k_{v100} - Wert nennt den Durchsatz in l/min für Wasser bei 20° C und einem Δp von 1 bar bei völlig geöffnetem Ventil

Dimensioni

Dimensions

Dimensions

Dimensionen

CMDV

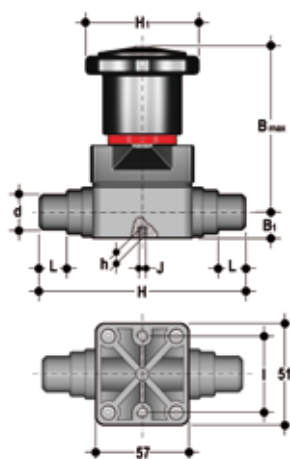

d	DN	PN	B max	B ₁	H ₁	H	h	l	J	L	g
20	15	6	86	15	58,5	124	8	35	M5	17	310

CMIV

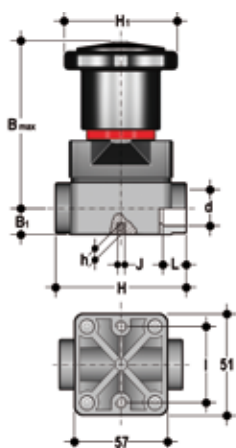

d	DN	PN	B max	B ₁	H ₁	H	h	l	J	L	g
16	12	6	86	15	58,5	75	8	35	M5	14	270
20	15	6	86	15	58,5	75	8	35	M5	16	270

CMFV

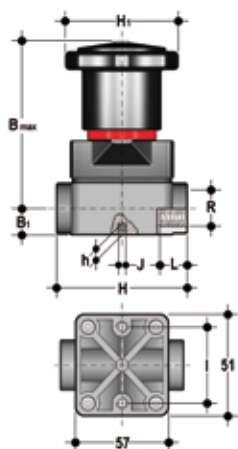

R	DN	PN	B max	B ₁	H ₁	H	h	I	J	L	g
3/8"	12	6	86	15	58,5	75	8	35	M5	11,5	270
1/2"	15	6	86	15	58,5	75	8	35	M5	15	270

CMUIV

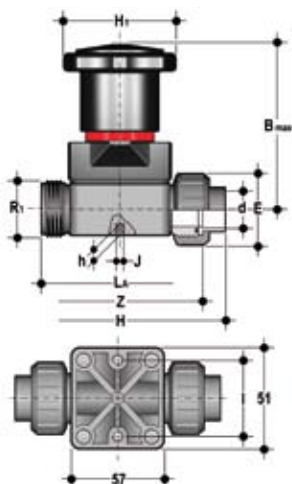

d	DN	PN	B max	H ₁	H	h	I	J	L _A	Z	R ₁	E	g
20	15	6	86	58,5	129,5	8	35	M5	90	97,5	1"	41	285

CMUFV

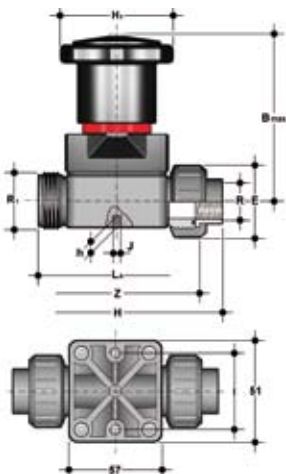

R	DN	PN	B max	H ₁	H	h	I	J	L _A	Z	R ₁	E	g
1/2"	15	6	86	58,5	129,5	8	35	M5	90	97,5	1"	41	285

CM PVC-U

**Installazione
sull'impianto**

**Connection to the
system**

**Montage sur
l'installation**

**Einbau in eine
Leitung**

CM PVC-U

Smontaggio

Disassembly

Démontage

Demontage

Montaggio

Assembly

Montage

Montage

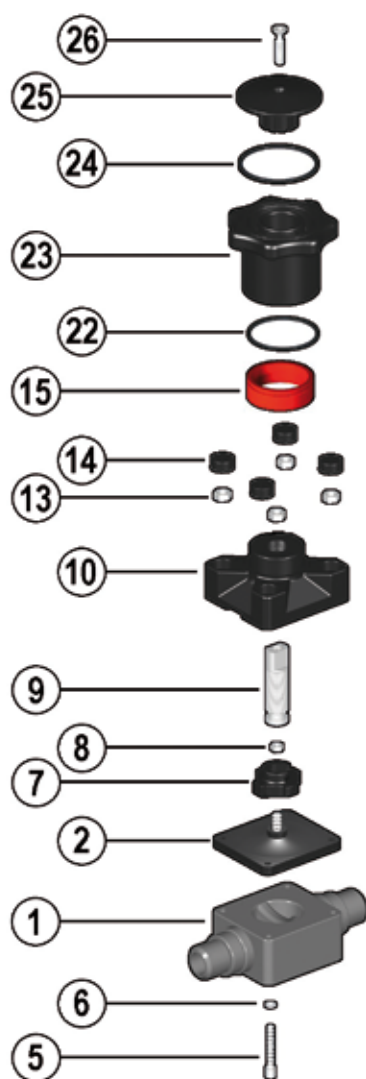

CM PVC-U

Pos.	Componenti	Materiale	Q.tà	Pos.	Composants	Materiaux	Q.té
1	Cassa	PVC-U	1	1	Corps	PVC-U	1
2	Membrana di tenuta	EPDM, FPM, PTFE	1	2	Membrane	EPDM, FPM, PTFE	1
5	Vite di fissaggio	Acciaio inox	4	5	Vis de fixation	Acier inox	4
6	Rondella	Acciaio inox	4	6	Rondelle	Acier inox	4
7	Otturatore	PA-GR	1	7	Compresseur	PA-GR	1
8	Dado	Acciaio inox	1	8	Ecrus	Acier inox	1
9	Stelo	Acciaio inox	1	9	Tige	Acier inox	1
10	Attuatore manuale	PA-GR	1	10	Actuateur manuel	PA-GR	1
13	Dado	Acciaio inox	4	13	Ecrus	Acier inox	4
14	Cappello di protezione	POM	4	14	Chapeau de protection	POM	4
15	Indicatore visivo	PVDF	1	15	Indicateur visuel	PVDF	1
22	O-ring	NBR	1	22	O-ring	NBR	1
23	Volantino	PA-GR	1	23	Volant	PA-GR	1
24	O-ring	NBR	1	24	O-ring	NBR	1
25	Coperchio	PA-GR	1	25	Couvercle	PA-GR	1
26	Vite di fissaggio	Acciaio inox	1	26	Vis de fixation	Acier inox	1

Pos.	Components	Material	Q.ty	Pos.	Benennung	Werkstoff	Menge
1	Valve Body	PVC-U	1	1	Gehäuse	PVC-U	1
2	Diaphragm	EPDM, FPM, PTFE	1	2	Membrane	EPDM, FPM, PTFE	1
5	Fixing Screw	Stainless steel	4	5	Schraube	Edelstahl	4
6	Washer	Stainless steel	4	6	Scheibe	Edelstahl	4
7	Compressor	PA-GR	1	7	Druckstück	PA-GR	1
8	Nut	Stainless steel	1	8	Mutter	Edelstahl	1
9	Stem	Stainless steel	1	9	Spindel	Edelstahl	1
10	Bonnet	PA-GR	1	10	Unterteil	PA-GR	1
13	Nut	Stainless steel	4	13	Mutter	Edelstahl	4
14	Protection Cap	POM	4	14	Abdeckung	POM	4
15	Visual Indicator	PVDF	1	15	Sichanzeige	PVDF	1
22	O-ring	NBR	1	22	O-ring	NBR	1
23	Handwheel	PA-GR	1	23	Handrad	PA-GR	1
24	O-ring	NBR	1	24	O-ring	NBR	1
25	Cap	PA-GR	1	25	Kappe	PA-GR	1
26	Fixing Screw	Stainless steel	1	26	Schraube	Edelstahl	1

Code

CMDV pag. 206

d	EPDM	FPM	PTFE
20	CMDV020E	CMDV020F	CMDV020P

CMFV pag. 207

R	EPDM	FPM	PTFE
3/8"	CMFV038E	CMFV038F	CMFV038P
1/2"	CMFV012E	CMFV012F	CMFV012P

CMIV pag. 206

d	EPDM	FPM	PTFE
16	CMIV016E	CMIV016F	CMIV016P
20	CMIV020E	CMIV020F	CMIV020P

CMUFV pag. 207

d	EPDM	FPM	PTFE
1/2"	CMUFV012E	CMUFV012F	CMUFV012P

CMUIV pag. 207

d	EPDM	FPM	PTFE
20	CMUIV020E	CMUIV020F	CMUIV020P